

## Vortex Tubes

**Cold air to -50°F (-46°C)  
from your compressed  
air supply — with no  
moving parts!**



### What Is A Vortex Tube?

A low cost, reliable, maintenance free solution to a variety of industrial spot cooling problems. Using an ordinary supply of compressed air as a power source, vortex tubes create two streams of air, one hot and one cold, **with no moving parts**. Vortex tubes can produce:

- Temperatures from -50° to +260°F (-46° to +127°C)
- Flow rates from 1 to 150 SCFM (28 to 4248 SLPM)
- Refrigeration up to 10,200 Btu/hr. (2571 Kcal/hr.)

Temperatures, flows and refrigeration are adjustable over a wide range using the control valve on the hot end exhaust.

### Why EXAIR Vortex Tubes?

EXAIR Vortex Tubes are constructed of **stainless steel**. The wear resistance of stainless steel, as well as its resistance to corrosion and oxidation, assures that EXAIR Vortex Tubes will provide years of reliable, maintenance-free operation.



A 1/4 ton of refrigeration in the palm of your hand!

### Applications

- Cooling electronic controls
- Cooling machining operations
- Cooling CCTV cameras
- Setting hot melts
- Cooling soldered parts
- Cooling gas samples
- Electronic component cooling
- Cooling heat seals
- Cooling environmental chambers

### Advantages

- No moving parts
- No electricity or chemicals
- Small, lightweight
- Low cost
- Maintenance free
- Instant cold air
- Durable - stainless steel
- Adjustable temperature
- Interchangeable generators

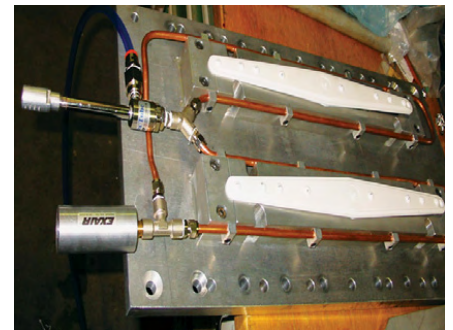

A Model 3225 Vortex Tube keeps plastic dishwasher arms cool during ultrasonic welding.



Special high temperature vortex tubes keep a boroscope lens cool while inserted into a 1200°F boiler porthole.



Cold air from a Model 3230 Vortex Tube quickly cools extruded plastic tubing.

Vortex Tubes & Spot Cooling

# Vortex Tubes

## How A Vortex Tube Works

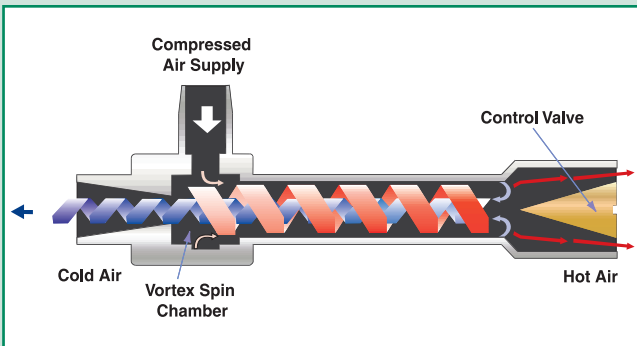

Compressed air, normally 80-100 PSIG (5.5 - 6.9 BAR), is ejected tangentially through a generator into the **vortex spin chamber**. At up to 1,000,000 RPM, this air stream revolves toward the hot end where some escapes through the **control valve**. The remaining air, still spinning, is forced back through the center of this outer vortex. The inner stream gives off kinetic energy in the form of heat to the outer stream and exits the vortex tube as **cold air**. The outer stream exits the opposite end as **hot air**. There is a detailed discussion of vortex tube history and theory later on page 139 in this section.

## Controlling Temperature And Flow In A Vortex Tube

Cold airflow and temperature are easily controlled by adjusting the slotted valve in the hot air outlet. **Opening the valve reduces the cold airflow and the cold air temperature. Closing the valve increases the cold airflow and the cold air temperature.** The percentage of air directed to the cold outlet of the vortex tube is called the “cold fraction”. In most applications, a cold fraction of 80% produces a combination of cold flow rate and temperature drop that maximizes refrigeration, or Btu/hr. (Kcal/hr.), output of a vortex tube. While low cold fractions (less than 50%) produce lowest temperatures, cold airflow rate is sacrificed to achieve them.

Most industrial applications, i.e., process cooling, part cooling, chamber cooling, require maximum refrigeration and utilize the 3200 series Vortex Tube. Certain “cryogenic” applications, i.e., cooling lab samples, circuit testing, are best served by the 3400 series Vortex Tube.

Setting a vortex tube is easy. Simply insert a thermometer in the cold air exhaust and set the temperature by adjusting the valve at the hot end. **Maximum refrigeration (80% cold fraction) is achieved when cold air temperature is 50°F (28°C) below compressed air temperature.**

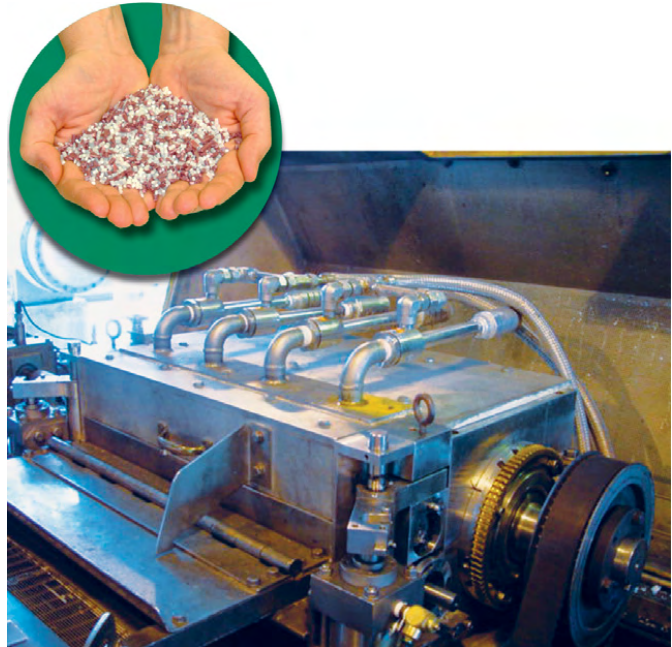

(4) Model 3250 Vortex Tubes cool the cutting knives in this pelletizer to prevent irregular shapes.

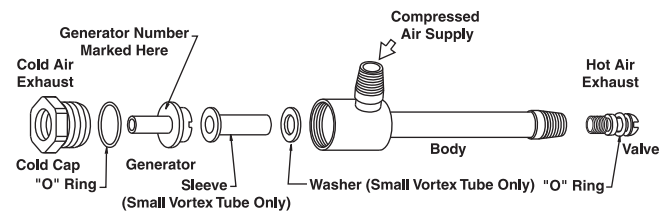

Model 3930 EXAIR Cooling Kit

If you are unsure of your flow and temperature requirements, EXAIR recommends the purchase of an **EXAIR Cooling Kit**. It contains a vortex tube, cold air muffer, air line filter and all generators required to experiment with the full range of airflows and temperatures.

## Selecting The Right Vortex Tube

EXAIR Vortex Tubes are available in three sizes. Each size can produce a number of flow rates, as determined by a small internal part called a **generator**. If Btu/hr. (Kcal/hr.) requirements, or flow and temperature requirements are known, simply select the appropriate vortex tube according to the specification information shown below or the performance charts shown on the following page. Keep in mind that the **vortex generators are interchangeable**. If, for example, a Model 3215 Vortex Tube does not provide sufficient cooling, you need only change generators within the vortex tube to upgrade the flow rate from 15 to 25, 30 or 40 SCFM (425 to 708, 850 or 1133 SLPM). Generator part numbers are shown in the "Accessories" listing on page 140.

## Vortex Tube Dimensions

### Small

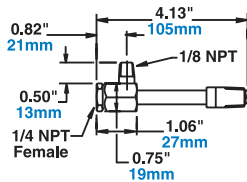

### With Mufflers

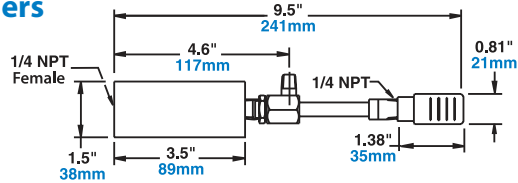

### Medium

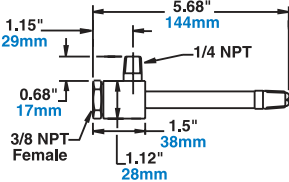

### With Mufflers

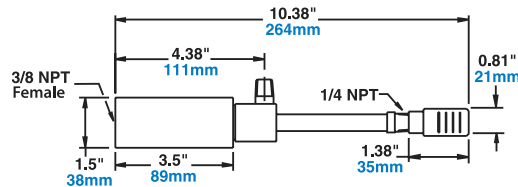

### Large

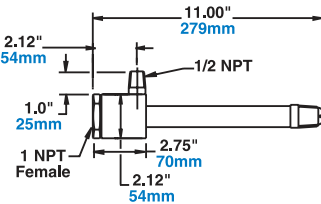

### With Mufflers

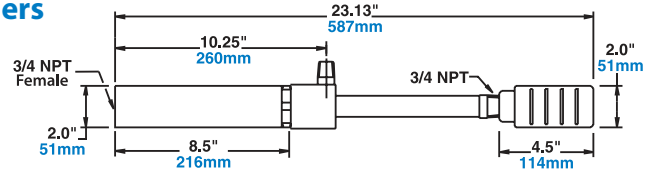

## Vortex Tube Specifications

3200 series Vortex Tubes optimize temperature drop and airflow to **produce maximum cooling power or Btu/hr. (Kcal/hr.)**. Specify 3200 series Vortex Tubes for most general cooling applications.

3400 series Vortex Tubes provide **lowest cold air temperatures, but at low cold airflow (when less than a 50% cold fraction is used)**. Specify 3400 series Vortex Tubes only where temperatures below 0°F (-18°C) are desired.

3200 Series Vortex Tube Specifications							3400 Series Vortex Tube Specifications						
Model	SCFM*	SLPM*	Btu/hr.**	Kcal/hr.**	SIZE	dBa***	Model	SCFM*	SLPM*	Btu/hr.**	Kcal/hr.**	SIZE	dBa***
3202	2	57	135	34	Small	68	3402	2	57	-----	-----	Small	67
3204	4	113	275	69	Small	70	3404	4	113	-----	-----	Small	69
3208	8	227	550	139	Small	76	3408	8	227	-----	-----	Small	75
3210	10	283	650	164	Medium	80	3410	10	283	-----	-----	Medium	78
3215	15	425	1,000	252	Medium	81	3415	15	425	-----	-----	Medium	80
3225	25	708	1,700	428	Medium	82	3425	25	708	-----	-----	Medium	82
3230	30	850	2,000	504	Medium	84	3430	30	850	-----	-----	Medium	84
3240	40	1,133	2,800	706	Medium	88	3440	40	1,133	-----	-----	Medium	87
3250	50	1,416	3,400	857	Large	94	3450	50	1,416	-----	-----	Large	93
3275	75	2,124	5,100	1,285	Large	96	3475	75	2,124	-----	-----	Large	96
3298	100	2,832	6,800	1,714	Large	96	3498	100	2,832	-----	-----	Large	96
3299	150	4,248	10,200	2,570	Large	97	3499	150	4,248	-----	-----	Large	96

\*SCFM (SLPM) at 100 PSIG (6.9 BAR) Inlet Pressure

\*\*Btu/hr. (Kcal/hr.) Cooling Capacity at 100 PSIG (6.9 BAR)

\*\*\*Noise levels taken with hot and cold mufflers installed.

\*SCFM (SLPM) at 100 PSIG (6.9 BAR) Inlet Pressure

\*\*Not Applicable. 3400 series Vortex Tubes are not normally used in air conditioning applications.

# Vortex Tubes

## Vortex Tube Performance

The **Vortex Tube Performance Charts** below give approximate temperature drops (and rises) **from inlet air temperature** produced by a vortex tube set at each cold fraction. Assuming no fluctuation of inlet temperature or pressure, a vortex tube will reliably maintain temperature within  $\pm 1^\circ\text{F}$ .

Pressure Supply	Cold Fraction %						
PSIG	20	30	40	50	60	70	80
20	62	60	56	51	44	36	28
	15	25	36	50	64	83	107
40	88	85	80	73	63	52	38
	21	35	52	71	92	117	147
60	104	100	93	84	73	60	46
	24	40	59	80	104	132	166
80	115	110	102	92	80	66	50
	25	43	63	86	113	143	180
100	123	118	110	100	86	71	54
	26	45	67	90	119	151	191
120	129	124	116	104	91	74	55
	26	46	69	94	123	156	195

Numbers in **shaded** area give temperature drop of cold air,  $^\circ\text{F}$ .  
Numbers in white area give temperature rise of hot air,  $^\circ\text{F}$ .

Pressure Supply	Cold Fraction % (METRIC)						
BAR	20	30	40	50	60	70	80
1.4	34.4	33.3	31.1	28.3	24.4	20.0	15.6
	8.3	13.9	20.0	28.3	35.6	46.1	59.4
2	40.9	39.6	37.1	33.8	29.2	24.0	18.1
	9.8	16.4	24.0	33.3	42.6	54.6	69.5
3	50.4	48.7	45.7	41.6	36.0	29.7	21.9
	12.0	19.9	29.6	40.3	52.3	66.5	83.5
4	56.9	54.7	50.9	46.1	40.0	32.9	25.1
	13.2	21.9	32.4	43.9	57.1	72.5	91.2
5	61.6	59.0	54.8	49.4	43.0	35.4	26.9
	13.7	23.3	34.2	46.5	60.9	77.2	97.1
6	65.4	62.7	58.2	52.7	45.6	37.6	28.6
	14.1	24.3	35.8	48.6	63.9	81.0	102.1
7	68.6	65.8	61.4	55.7	48.0	39.6	30.0
	14.4	25.1	37.3	50.2	66.3	84.2	106.3
8	71.1	68.2	63.8	57.3	50.0	40.8	30.4
	14.4	25.4	38.1	51.8	67.9	86.1	107.9

Numbers in **shaded** area give temperature drop of cold air,  $^\circ\text{C}$ .  
Numbers in white area give temperature rise of hot air,  $^\circ\text{C}$ .

**Back Pressure:** The performance of a vortex tube deteriorates with back pressure on the cold air exhaust. Low back pressure, up to 2 PSIG (.1 BAR), will not change performance. 5 PSIG (.3 BAR) will change performance by approximately  $5^\circ\text{F}$  ( $2.8^\circ\text{C}$ ).

**Filtration:** The use of clean air is essential, and filtration of 25 microns or less is recommended. EXAIR filters contain a 5 micron element and are properly sized for flow.

**Inlet Air Temperature:** A vortex tube provides a temperature drop from supply air temperature (see Performance Charts above). Elevated inlet temperatures will produce a corresponding rise in cold air temperatures.

**Noise Muffling:** EXAIR offers mufflers for both the hot and cold air discharge. Normally, muffling is not required if the cold air is ducted.

**Regulation:** For best performance, use line pressures of 80 to 110 PSIG (5.5 to 7.6 BAR). Maximum pressure rating is 250 PSIG (17.2 BAR), minimum 20 PSIG (1.4 BAR).

## EXAIR Products Using Vortex Tubes

Over the years, the basic vortex tube has been used in virtually hundreds of industrial cooling applications. A few have become so popular as to warrant the development

of an “applied product” designed to suit the specific application. These products include the Adjustable Spot Cooler, Mini Cooler, Cold Gun and Cabinet Coolers that can be found in the remainder of this catalog.



## High Temperatures

Vortex tubes for ambient temperatures above  $200^\circ\text{F}$  ( $93^\circ\text{C}$ ) are available. Contact an Application Engineer at 1-800-903-9247 for more details.

## Preset Vortex Tubes

EXAIR can provide vortex tubes preset to any combination of flow and temperature desired. To prevent tampering with the desired setting, a drilled orifice that replaces the adjustable hot valve is available. For more information, please contact an Application Engineer.

## Cooling Vacuum Formed Parts

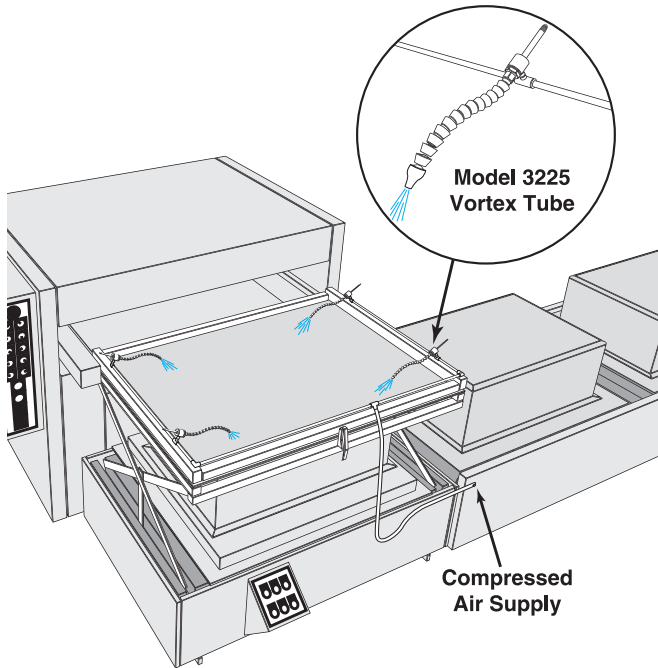

**The Problem:** A manufacturer of major appliances vacuum forms the plastic interior shell of refrigerators. The deep draw of the plastic and complex geometry left the four corners unacceptably thin. The corners

would tear during assembly or bulge when insulation was inserted between the shell and exterior housing, resulting in a high rejection rate.

**The Solution:** (4) Model 3225 Vortex Tubes were positioned to cool the critical corner areas just prior to forming the plastic sheet. By cooling these areas, less stretching of the plastic occurred which resulted in thicker corners.

**Comment:** Rejected parts become very costly, especially when expensive materials and slow process times are involved. The cold air from the vortex tube is just the solution for big problems like this one. It can supply “instant” cold air down to -50°F (-46°C) from an ordinary compressed air supply. Along with cooling other vacuum formed parts such as spas, bathtubs, tote pans and waste cans, it is ideal for cooling hot melts, ultrasonic welders, environmental chambers, etc.

This is an ideal application for EXAIR’s EFC, an electronic flow control for compressed air, shown on page 4. It reduces air consumption by turning on the compressed air for a preset length of time, when sensing the plastic sheet is in position.

## Cooling An Ultrasonic Weld

**The Problem:** A manufacturer of toothpaste seals the ends of plastic tubes with an ultrasonic welder prior to filling. As heat built up at the sealing jaw of the welder, release of the tubes was delayed. Tubes that were too hot would not seal resulting in a high rate of rejection.

**The Solution:** A Model 3215 Vortex Tube was used to direct cold air at the jaw of the welder. The cooling was transferred through the metal jaw to the tube seam while in the clamped position. **Process time was reduced and rejected tubes were eliminated.**

**Comment:** It amazes most people that the cooling from a small vortex tube can dramatically improve quality and throughput. The vortex tube is the low cost solution for cooling parts, chambers, heat seals and various processes. They’re easy to use, can be adjusted to produce cold air down to -50°F (-46°C) and have no moving parts to wear out.

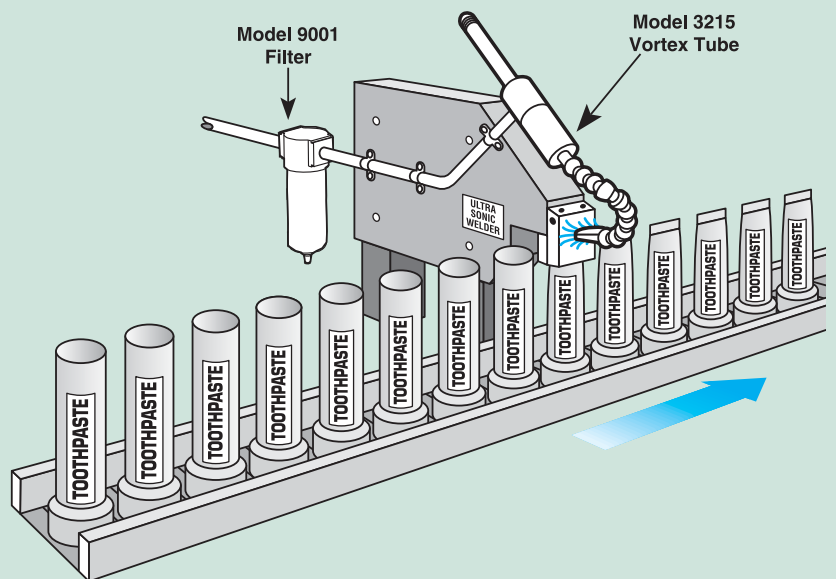

Vortex Tubes & Spot Cooling

# Vortex Tubes

## Cooling Blow Molded Fuel Tanks

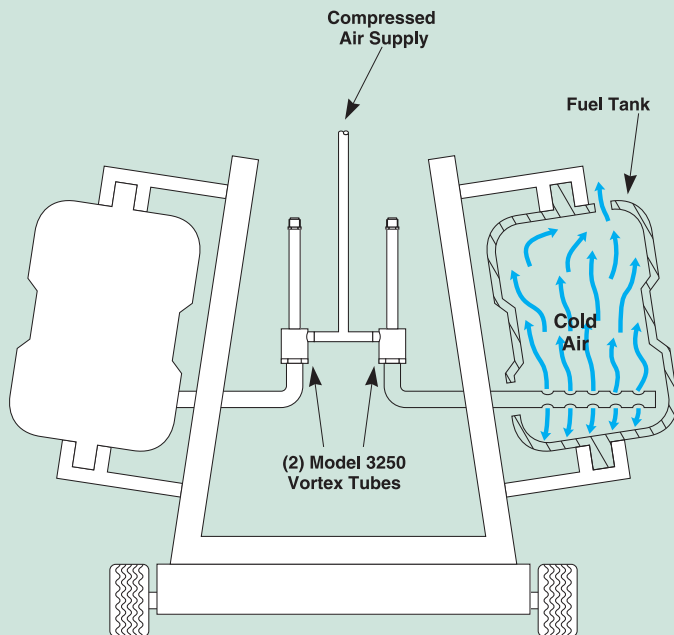

**The Problem:** Automobile fuel tanks are blow molded, then clamped to a fixture to prevent distortion during the cooling cycle. The cooling time of over 3 minutes required for each tank created a bottleneck in the production process.

**The Solution:** (2) Model 3250 Vortex Tubes were mounted to the cooling rack and connected to a compressed air line. Cold air produced by the vortex tubes was circulated inside the fuel tanks. **Cooling time was reduced from three minutes to two minutes for each tank, improving productivity by 33%.**

**Comment:** It's hard to imagine an application better suited to vortex cooling than this one. The vortex tubes' small size and light weight simplified mounting to the cooling rack. No moving parts assured reliability and maintenance-free operation in a hostile environment. Finally, the cold airstream was easily channeled to the fuel tank via the threaded cold air outlet. When the cooling problem includes the need for simplicity, reliability and compact design, a vortex tube is very often the best choice.

## Cooling Small Parts After Brazing

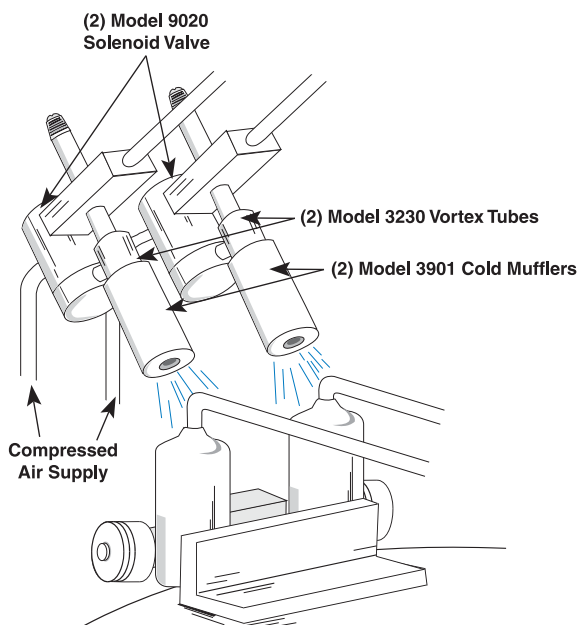

**The Problem:** Air conditioner parts assembled on an automatic brazing machine must be cooled to handling temperature prior to removal. The machine was capable of brazing up to four hundred pieces per hour. However, the time required for the parts to cool severely limited the production rate. Water cooling was unacceptable from the standpoint of both housekeeping and part contamination.

**The Solution:** (2) Model 3230 Vortex Tubes (with cold air mufflers installed) were used to blow cold air on the parts after the brazing cycle. The vortex tubes were set at an 80% cold airflow (cold fraction) to produce maximum refrigeration. **The parts were cooled from a brazing temperature of 1450°F (788°C) to a handling temperature of 120°F (49°C) within 20 seconds, allowing the machine to operate at its maximum production rate.**

**Comment:** Compared to conventional refrigeration or water cooling, vortex tubes offer a number of advantages: low cost, compact design, inherent reliability and cleanliness. These attributes make vortex tubes the cost effective choice for many small part cooling operations.

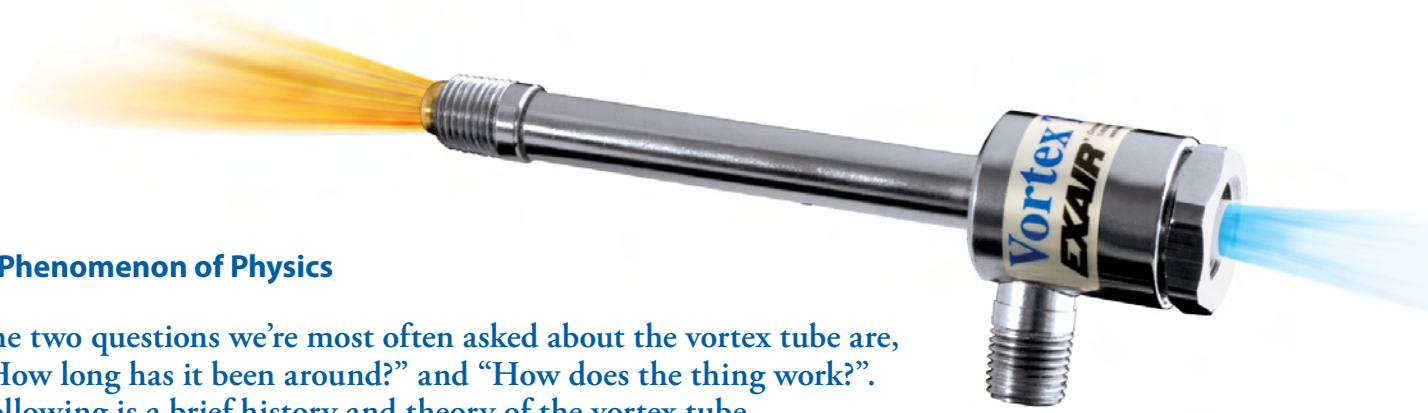

## A Phenomenon of Physics

The two questions we're most often asked about the vortex tube are, "How long has it been around?" and "How does the thing work?". Following is a brief history and theory of the vortex tube.

The vortex tube was invented quite by accident in 1928. George Ranque, a French physics student, was experimenting with a vortex-type pump he had developed when he noticed warm air exhausting from one end, and cold air from the other. Ranque soon forgot about his pump and started a small firm to exploit the commercial potential for this strange device that produced hot and cold air with no moving parts. However, it soon failed and the vortex tube slipped into obscurity until 1945 when Rudolph Hilsch, a German physicist, published a widely read scientific paper on the device.

Much earlier, the great nineteenth century physicist, James Clerk Maxwell, postulated that since heat involves the movement of molecules, we might someday be able to get hot and cold air from the same device with the help of a "friendly little demon" who would sort out and separate the hot and cold molecules of air.

Thus, the vortex tube has been variously known as the "*Ranque Vortex Tube*", the "*Hilsch Tube*", the "*Ranque-Hilsch Tube*", and "*Maxwell's Demon*". By any name, it has in recent years gained acceptance as a simple, reliable and low cost answer to a wide variety of industrial spot cooling problems.

**A vortex tube uses compressed air as a power source, has no moving parts, and produces hot air from one end and cold air from the other. The volume and temperature of these two airstreams are adjustable with a valve built into the hot air exhaust. Temperatures as low as -50°F (-46°C) and as high as +260°F (+127°C) are possible.**

**Theories abound regarding the dynamics of a vortex tube. Here is one widely accepted explanation of the phenomenon:**

Compressed air is supplied to the vortex tube and passes through nozzles that are tangent to an internal counterbore. These nozzles set the air in a vortex motion. This spinning stream of air turns 90° and passes down the hot tube in the form of a spinning shell, similar to a tornado. A valve at one end of the tube allows some of the warmed air to escape. What does not escape, heads back down the tube as a second vortex inside the low-pressure area of the larger vortex. This inner vortex loses heat and exhausts through the other end as cold air.

While one airstream moves up the tube and the other down it, both rotate in the same direction at the same angular velocity. That is, a particle in the inner stream completes one rotation in the same amount of time as a particle in the outer stream. However, because of the principle of conservation of angular momentum, the rotational speed of the smaller vortex might be expected to increase. (The conservation principle is demonstrated by spinning skaters who can slow or speed up their spin by extending or drawing in their arms.) But in the vortex tube, the speed of the inner vortex remains the same. Angular momentum has been lost from the inner vortex. The energy that is lost shows up as heat in the outer vortex. Thus the outer vortex becomes warm, and the inner vortex is cooled.

Vortex Tubes & Spot Cooling

# Vortex Tubes

## EXAIR Cooling Kits

EXAIR Cooling Kits include a vortex tube, all generators, cold muffler, fitting, tubing and clips to duct cold air, and filter separator.

Model #	Description
3908	Cooling Kit up to 550 Btu/hr. (139 Kcal/hr.), Small Size
3930	Cooling Kit up to 2800 Btu/hr. (706 Kcal/hr.), Medium Size
3998	Cooling Kit up to 10,200 Btu/hr. (2570 Kcal/hr.), Large Size

## Vortex Tubes

Model #	Description
3202	Vortex Tube, 2 SCFM (57 SLPM), for max. refriger., 135 Btu/hr. (34 Kcal/hr.), Small Size
3204	Vortex Tube, 4 SCFM (113 SLPM), for max. refriger., 275 Btu/hr. (69 Kcal/hr.), Small Size
3208	Vortex Tube, 8 SCFM (227 SLPM), for max. refriger., 550 Btu/hr. (139 Kcal/hr.), Small Size
3210	Vortex Tube, 10 SCFM (283 SLPM), for max. refriger., 650 Btu/hr. (164 Kcal/hr.), Medium Size
3215	Vortex Tube, 15 SCFM (425 SLPM), for max. refriger., 1000 Btu/hr. (252 Kcal/hr.), Medium Size
3225	Vortex Tube, 25 SCFM (708 SLPM), for max. refriger., 1700 Btu/hr. (428 Kcal/hr.), Medium Size
3230	Vortex Tube, 30 SCFM (850 SLPM), for max. refriger., 2000 Btu/hr. (504 Kcal/hr.), Medium Size
3240	Vortex Tube, 40 SCFM (1133 SLPM), for max. refriger., 2800 Btu/hr. (706 Kcal/hr.), Medium Size
3250	Vortex Tube, 50 SCFM (1416 SLPM), for max. refriger., 3400 Btu/hr. (857 Kcal/hr.), Large Size
3275	Vortex Tube, 75 SCFM (2124 SLPM), for max. refriger., 5100 Btu/hr. (1285 Kcal/hr.), Large Size
3298	Vortex Tube, 100 SCFM (2832 SLPM), for max. refriger., 6800 Btu/hr. (1714 Kcal/hr.), Large Size
3299	Vortex Tube, 150 SCFM (4248 SLPM), for max. refriger., 10,200 Btu/hr. (2570 Kcal/hr.), Large Size
3402	Vortex Tube, 2 SCFM (57 SLPM), for max. cold temperature, Small Size
3404	Vortex Tube, 4 SCFM (113 SLPM), for max. cold temperature, Small Size
3408	Vortex Tube, 8 SCFM (227 SLPM), for max. cold temperature, Small Size
3410	Vortex Tube, 10 SCFM (283 SLPM), for max. cold temperature, Medium Size
3415	Vortex Tube, 15 SCFM (425 SLPM), for max. cold temperature, Medium Size
3425	Vortex Tube, 25 SCFM (708 SLPM), for max. cold temperature, Medium Size
3430	Vortex Tube, 30 SCFM (850 SLPM), for max. cold temperature, Medium Size
3440	Vortex Tube, 40 SCFM (1133 SLPM), for max. cold temperature, Medium Size
3450	Vortex Tube, 50 SCFM (1416 SLPM), for max. cold temperature, Large Size
3475	Vortex Tube, 75 SCFM (2124 SLPM), for max. cold temperature, Large Size
3498	Vortex Tube, 100 SCFM (2832 SLPM), for max. cold temperature, Large Size
3499	Vortex Tube, 150 SCFM (4248 SLPM), for max. cold temperature, Large Size

## Vortex Tube Accessories and Components

Model #	Description
3905	Cold Muffler for 2 through 8 SCFM (57-227 SLPM) Vortex Tube, Small Size
3901	Cold Muffler for 10 through 40 SCFM (283-1133 SLPM) Vortex Tube, Medium Size
3906	Cold Muffler for 50 through 150 SCFM (1416-4248 SLPM) Vortex Tube, Large Size
3903	Hot Muffler for 2 through 40 SCFM (57-1133 SLPM) Vortex Tube, Small & Medium Size
3907	Hot Muffler for 50 through 150 SCFM (1416-4248 SLPM) Vortex Tube, Large Size
3909	Generator Kit for 2 through 8 SCFM (57-227 SLPM) Vortex Tube, Small Size
3902	Generator Kit for 10 through 40 SCFM (283-1133 SLPM) Vortex Tube, Medium Size
3910	Generator Kit for 50 through 150 SCFM (1416-4248 SLPM) Vortex Tube, Large Size

Generator Kits ordered with a vortex tube include all generators for the specified tube. Permits setting the vortex tube for all capacities and styles.

**Generator Only** —Specify capacity (SCFM) and style ("R" for max. refrigeration, "C" for max. cold temperature).

**Example:**

15-R = 15 SCFM Generator for max. refrigeration

50-C = 50 SCFM Generator for max. cold temperature

## Accessories

Model #	Description
9001	Automatic Drain Filter Separator, 3/8 NPT, 65 SCFM (1841 SLPM)
9032	Automatic Drain Filter Separator, 1/2 NPT, 90 SCFM (2547 SLPM)
9002	Automatic Drain Filter Separator, 3/4 NPT, 220 SCFM (6230 SLPM)
9005	Oil Removal Filter, 3/8 NPT, 15-37 SCFM (425-1048 SLPM)
9006	Oil Removal Filter, 3/4 NPT, 50-150 SCFM (1415-4248 SLPM)
9015	Valve and Thermostat Kit (120V, 50/60 Hz), 1/4 NPT, 40 SCFM (1133 SLPM)

Other solenoid valves and thermostats available. Contact factory.

**Note:** Flow ratings shown (SCFM) assume 100 PSIG (6.9 BAR) inlet pressure. At other pressures, flow is proportional to absolute inlet pressure.



Order EXAIR's EFC™ electronic flow control to minimize compressed air use. See page 4 for details.



For Technical Assistance, Call An EXAIR Application Engineer 1-800-903-9247  
Toll Free FAX (866) 329-3924 • E-mail: techhelp@exair.com • www.exair.com

